



**SOMUN
GRUBU
NUTS**

KÖR SOMUN

HEX DOMED CAP NUT

SECHSKANT HUTMUTTERN

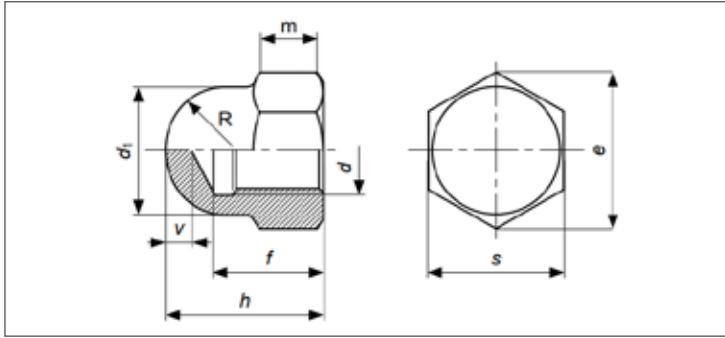

ISO	UNI	DIN
-	5721	1587
Mekanik Özellikler - Toleranslar Mechanical Properties - Tolerances Mechanische Eigenschaften - Toleranzen		ISO 898-2 UNI 3740-4 ISO 4759-1

TEKNİK BİLGİLER

TECHNICAL INFORMATION

TECHNISCHE INFORMATION

d		d1 max	s min	s max	m min	m max	e min	f min	f max	h min	h max	R »	v min	gr		
M3		5,00		5,50		2,40		6,08		4,00	5,00		2,50	1,00	1,09	
M4	Grade A	6,50	6,78	7,00	2,90	3,20	7,66	5,26	5,71	7,64	8,00		3,25	2,00	1,63	
	Grade B		6,64				7,50			7,42						
M5	Grade A	7,50	7,78	8,00	3,70	4,00	8,79	7,21	7,79	9,64	10,00		3,75	2,00	2,72	
	Grade B		7,64				8,63			9,42						
M6	Grade A	9,50	9,64	10,00	4,70	5,00	11,05	7,71	8,29	11,57	12,00		4,75	2,00	5,07	
	Grade B		9,78				10,89			11,30						
M8	Grade A	12,50	12,73	13,00	6,14	6,50	14,38	10,56	11,35	14,57	15,00		6,25	2,00	11,97	
	Grade B		12,57				14,20			14,30						
M10	Grade A	15,00	15,73	16,00	17,00	7,64	8,00	17,77	12,65	13,35	17,57	18,00	7,50	8,00	2,00	21,87
	Grade B		15,57					16,57			17,30					
M12	Grade A	17,00	17,73	18,00	19,00	9,64	10,00	20,03	15,65	16,35	21,48	22,00	8,50	9,00	3,00	30,79
	Grade B		17,57					18,48			19,85					
M14	Grade A	20,00	20,67	21,00	22,00	10,30	11,00	23,35	17,65	18,35	24,48	25,00	10,00	10,50	3,00 (4)	43,75
	Grade B		20,16					21,16			22,78					
M16	Grade A	23,00	23,67	24,00	12,30	13,00	26,75	20,58	21,42	27,48	28,00		11,50	3,00 (4)	59,07	
	Grade B		23,16				26,17			27,16						
M18	Grade A	26,00	26,16	27,00	14,30	15,00	30,14	24,58	25,42	31,38	32,00		13,00	3,00 (5)	103,40	
	Grade B		26,67				29,56			31,00						
M20	Grade A	28,00	29,67	30,00	14,90	16,00	33,53	25,58	26,42	33,38	34,00		14,00	3,00 (5)	113,10	
	Grade B		29,16				32,95			33,00						
M22	Grade A	31,00	31,61	32,00	34,00	16,90	18,00	35,72	28,58	29,42	38,38	39,00	15,5	16,50	3,00 (5)	140,30
	Grade B		31,00					33,00			35,03					
M24	Grade A	34,00	35,38	36,00	17,70	19,00	39,98	30,50	31,50	41,38	42,00		17,00	3,00 (6)	235,00	
	Grade B		35,00				39,55			41,00						

